

240 VOLT 1Ø 80 AMPS

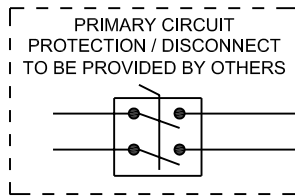

ZONE 1
8 KW MAX

ZONE 2
8 KW MAX

□ L1
□ L2

LOW VOLTAGE CONTROL INPUT

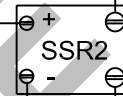
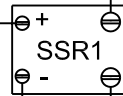
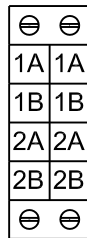

40 AMP

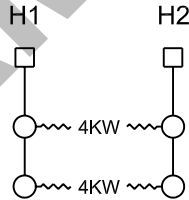

40 AMP

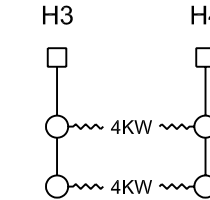

INFRATECH
WWW.INFRATECH-USA.COM

DESCRIPTION
2 RELAY MAIN CONTROL PANEL
240 VOLT SINGLE PHASE 80 AMP

CUSTOMER
SAMPLE

DATE Aug. 28, 2008	ITEM# X-30-4052
JOB# N/A	UL# SAMPLE

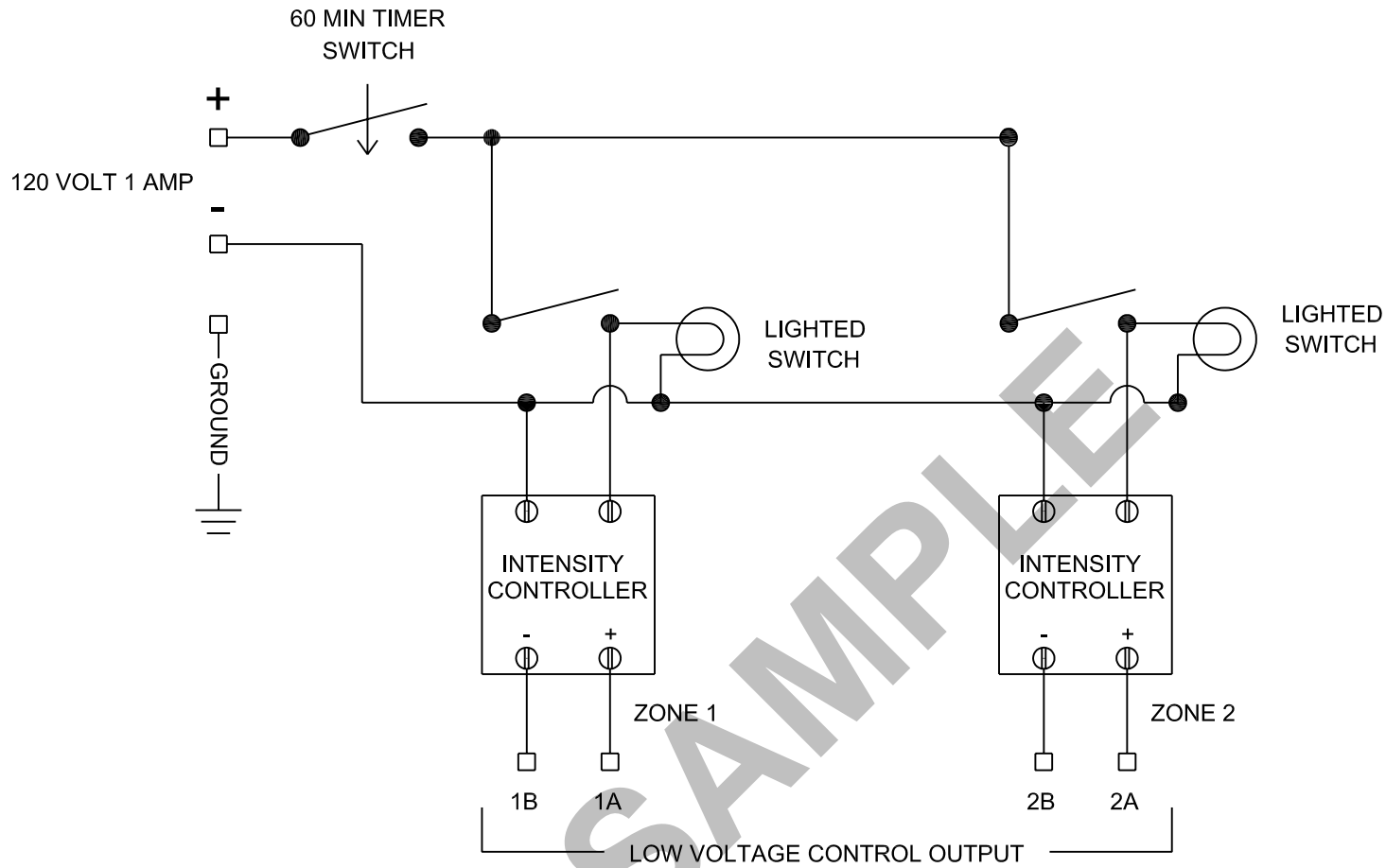

NOTE: USE TWISTED PAIR OR SHIELDED WIRE FOR LOW VOLTAGE HOOK-UP.

INFRATECH™		344 W. 157th Street Gardena, California 90248	
WWW.INFRATECH-USA.COM		Phone: (310) 354-1250 Fax: (310) 523-3674	
DESCRIPTION			
2 ZONE ANALOG REMOTE CONTROL UNIT			
CUSTOMER			
SAMPLE			
DATE	ITEM#	X-30-4033	
Aug. 28, 2008	JOB#	N/A	